

## Tools you need.

- ①Iron (30W)
- ②Solder wire
- ③Multimeter
- ④Tweezers
- ⑤Wire cutters

## Precautions::

- ①Check part values & quantities against part list
- ②Always meter resistor values before soldering
- ③Understand all part polarities and orientations

## EP-8

Simple electronic organ kit instructions

Rev. 1.0

January 6, 2018

Produced by YiQi

### 1.Install RES:

R1 ~ R6 = 2KΩ

R7, R9 = 1KΩ

R8 = 33KΩ, R10 = 22KΩ

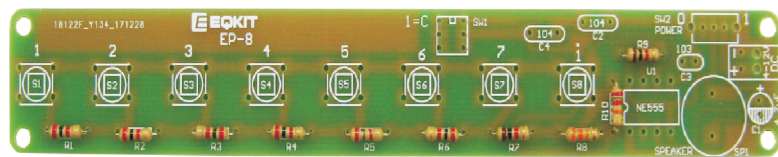

### 2.Install CAP:

C2 = C4 = 104PF

C3 = 103P

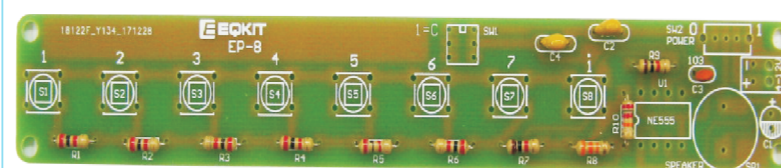

### 3.Install KEY :

Pay attention to the direction of the pin during installation

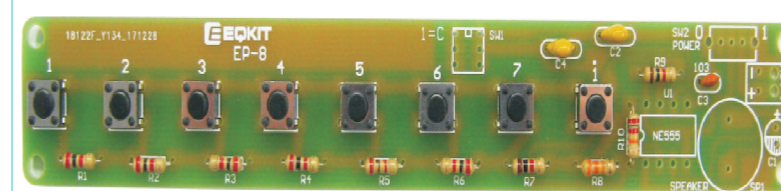

Warning:

The long foot of the electrolytic capacitor is the positive pole.  
Welding on the square pads on the circuit board

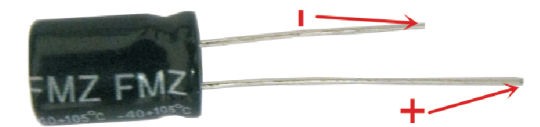

### 4.Install audio control keys:

Pay attention to the direction of the pin during installation.

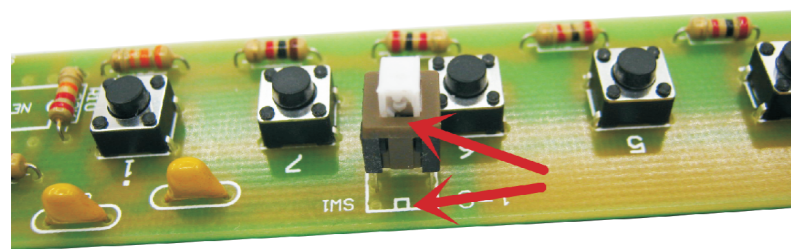

### 5.Install power SW :

Notice that each pin should be welded.

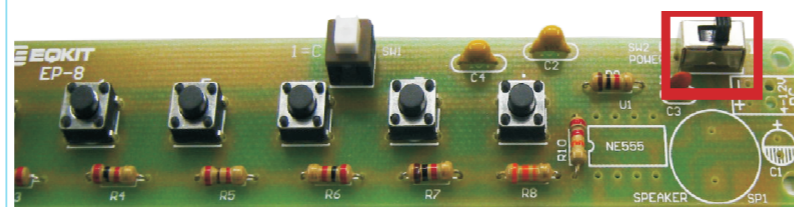

### 6.Install Integrated circuit :

U1 = NE555, Pay attention to the direction of the integrated circuit during installation

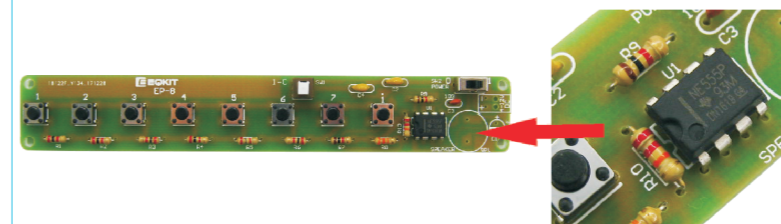

### 7.Install buzzer:

Passive buzzer has no installation direction

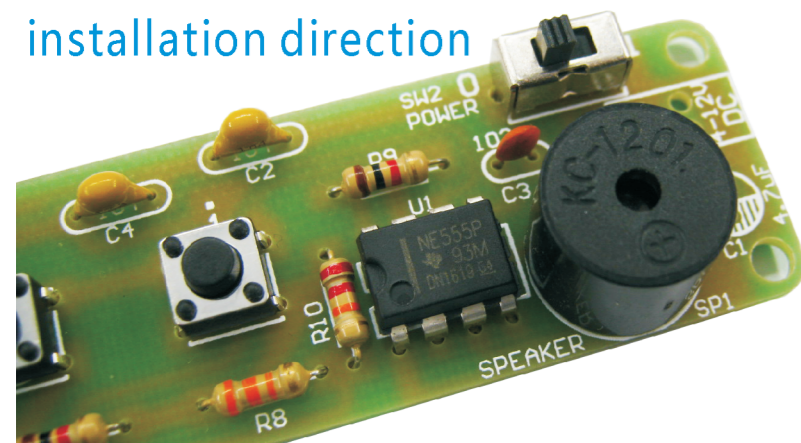

### 8.Install electrolytic capacitors:

C1 = 4.7uF, The long foot of the capacitor is the positive pole

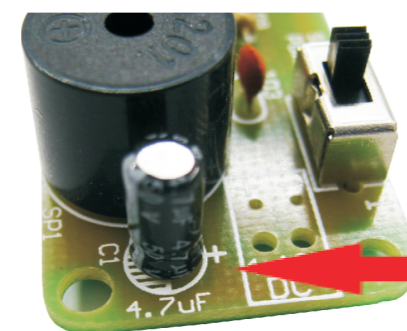

Welding positive pole here

### 9.Install battery box or power cable :

Weld the battery box or power cable according to the picture below  
The red cable is a positive power supply  
Black cable is a negative power supply

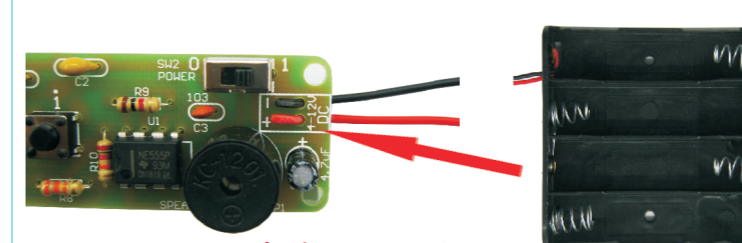

- ①Power supply is 4V to 12V
- ②Battery boxes or power cables need extra purchase

### Simple electronic organ component list

NO.	Name	Parameter	QTY
R7, R9	RES	1K	2
R1~R6	RES	2K	6
R10	RES	22K	1
R8	RES	33K	1
C3	Cap	103P	1
C2, C4	M-CAP	104P	2
C1	E-CAP	4.7uF	1
S1~S8	Key	6*6*5	8
SW1	Switch	6P	1
SW2	Switch	3P2D	1
SP1	Buzzer	Passive buzzer	1
U1	IC	NE555	1
-	PCB	EP-8	1

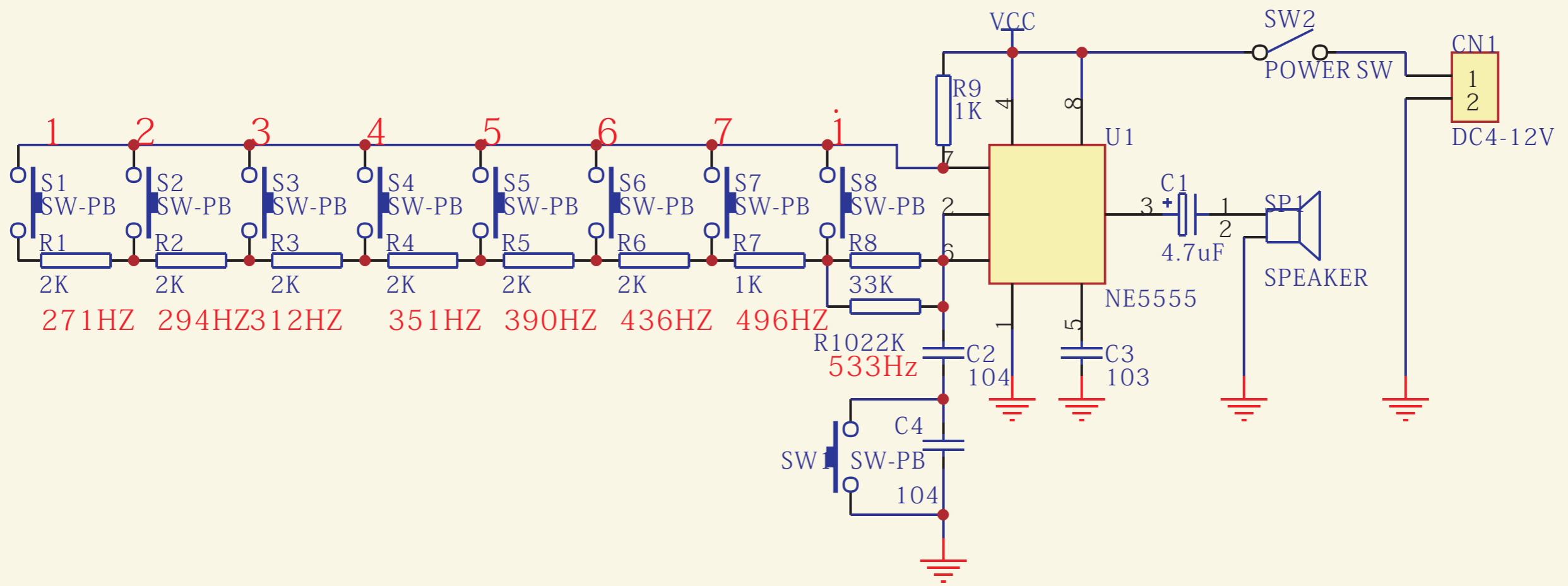

Title		
Size	Number	Revision
B		
Date:	6-Jan-2018	Sheet of
File:	E:\longyong.ddb	Drawn By: